



HAKKO 850

SMD REWORK STATION

INSTRUCTION MANUAL

CAUTION

REMOVE the pump shipping screw (M5×10, red) from the bottom of the 850 station before using it.

Leaving the screw in place will cause serious problems.
Be sure to SAVE THIS SCREW!

REPLACE the pump shipping screw (M5×10, red) into the bottom of the 850 station before transporting it.

Leaving the screw out will cause serious problems.

Table of Contents

Part Names	2
Before Operation	3
Precautions	4
Operating Instructions	5•6
Replacing the Heating Element	7
Temperature Distribution Chart	8•9
Specifications, Replacement Parts, Options	10

Part Names

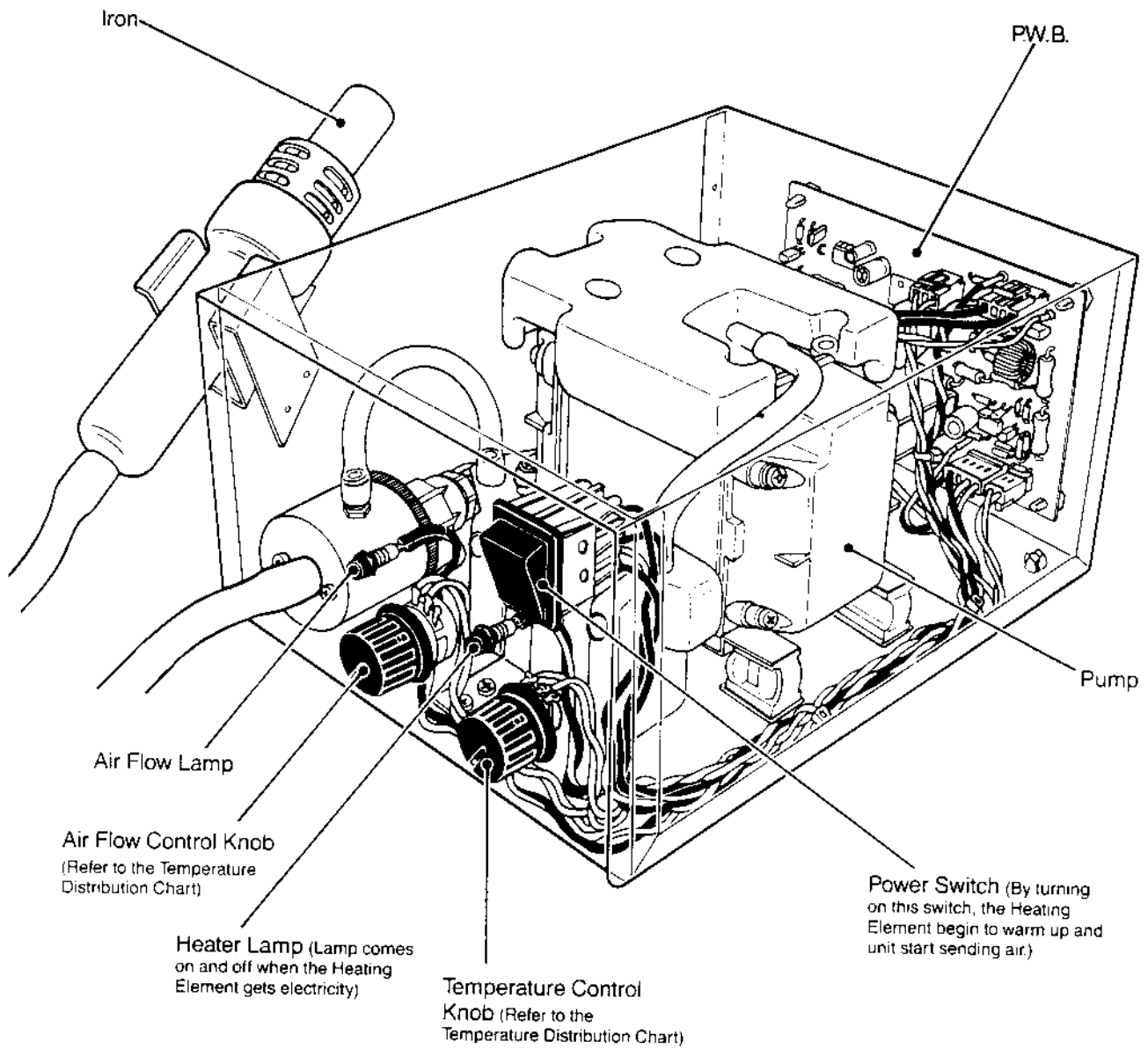

Accessories

FP Pick-up Wire 1 pc.

FP Pick-up 1 pc.

Before Operation

1. Remove the Pump Securing Screw.

Remove the pump securing screw (M5 × 10, marked red) from the bottom of the 850 station. Failure to do so may result in serious problems.

Pump Securing Screw

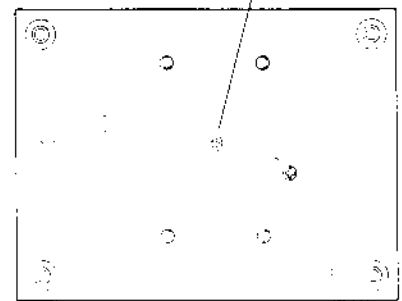

2. Select the FP Pick-up Wire that matches the size of the IC.

The FP Pick-up has an S wire (14mm) attached to it, but an L wire (30mm) may be necessary, depending on the size of the IC. Choose the appropriate wire for the IC.

3. Select the Nozzle that matches the size of the IC.

Attach the Nozzle when both the Pipe and the Nozzle are cool. Should either be warm, check to make sure that the Temperature Control Knob is set to 1.

Attaching the Nozzle.

1. Loosen the screw on the Nozzle.
2. Attach the Nozzle as shown in the drawing.

Do not force the Nozzle or pull on the edge of the Nozzle by pliers. Also, do not retighten the screw too tightly.

"B" attached at the end of part numbers except for single nozzles means that the nozzles have an M3 x 5 inside screw.

When installing an optional nozzle to the Hakko 850, do not remove this inside screw.

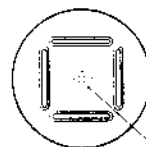
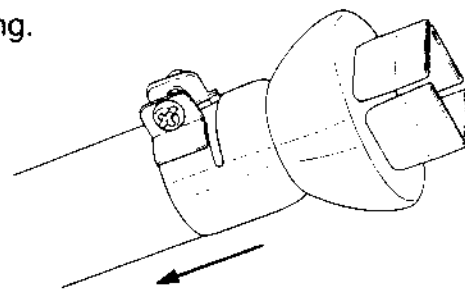

Inside screw M3 x 5

Precautions

1. Thermal Protector

For safety, power is automatically shut off should the unit exceed a certain temperature. Once the temperature has dropped to a safety level, power is automatically turned on.

If the thermal protector is tripped (the heater lamp turns off during use.), reduce the temperature setting or increase the air flow. Be sure not to operate the unit with the temperature and air flow settings that makes the thermal protector trip. This could damage the unit.

Should the thermal protector be tripped and you do not wish to continue the operation or if you leave that place, be sure to turn the Power Switch off.

2. Caution — High Temperature Operation

Do not use the 850 unit near ignitable gases, paper, or other inflammable materials. Both the nozzle and the heated air are extremely hot and can cause painful burns. Never touch the heater pipe or allow the heated air to blow against your skin. Initially, the iron may emit white smoke, but this will soon disappear.

3. After use, be sure to cool the unit.

After turning off the power switch, the unit will automatically blow cool air through the pipe for a short period of time. Do not disconnect the plug during this cooling process.

4. Never drop or sharply jolt the unit.

The pipe contains quartz glass which can break if the unit is dropped or jolted sharply.

5. Do not disassemble the pump.

6. Disconnect the plug when you don't use the unit for a long time.

When the power cord is connected into the power supply, the unit has a little flow of electricity, even the Power Switch is in off position. So when you don't use the unit for a long time, disconnect the plug.

Operating Instructions

QFP Desoldering

1. Plug the power cord into the power supply.

After connection, the automatic blowing function will start sending air through the pipe, but the Heating Element remains cool.

2. Turn the power switch on.

The Power Switch may be turned on at any time while the automatic blowing function is operating. Once the Power Switch is turned on, the Heating Element will begin to warm up.

3. Adjust the Air Flow and Temperature Control Knobs.

After adjusting the Air Flow and Temperature Control Knob, wait for the temperature to stabilize for a short period of time. Refer to the temperature distribution chart. For your reference, we recommend you to adjust the temperature around 300 to 350°C. As for Air Flow in case of single nozzle, set the knob 1 ~ 3, in another nozzle, set it from 4 ~ 6. When using a single nozzle, never set the Temperature Control Knob to higher than 6.

⚠WARNING

If the thermal protector is tripped (the heater lamp turns off during use), reduce the temperature setting or increase the air flow. Be sure not to operate the unit with the temperature and air flow settings that makes the thermal protector trip. This could damage the unit.

4. Place the FP Pick-up under the IC lead.

Slip the FP Pick-up Wire under the IC lead. If the width of the IC does not match the size of the FP Pick-up, adjust the width of the wire by supressing the wire.

5. Melt the solder.

Hold the iron so that the Nozzle is located directly over, but not touching the IC, and allow the hot air to melt the solder. Be careful not to touch the leads of the IC with the Nozzle.

6. Remove the IC.

Once the solder has melted, remove the IC by lifting the FP Pick-up.

7. Turn the Power Switch off.

After the Power Switch is turned off, an automatic blowing function begins sending cool air through the pipe in order to cool both the heating element and the handle.

So do not disconnect the plug during this cooling process.

In case you don't use the unit for a long time, disconnect the plug.

8. Remove any remaining solder.

After removing the IC, remove remaining solder with a wick or desoldering tool.

Note: In case of SOP, PLCC, desolder it by using tweezers, etc.

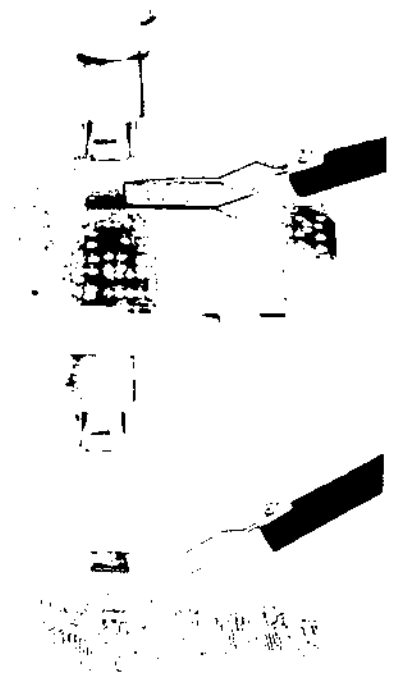

QFP Soldering

1. Apply the solder paste.

Apply the proper quantity of solder paste and install the SMD on the PWB.

2. Preheat SMD.

Refer to the photo to preheat SMD. (Fig. I)

3. Soldering

Heat the lead frame evenly.

(Fig. II)



Fig. II

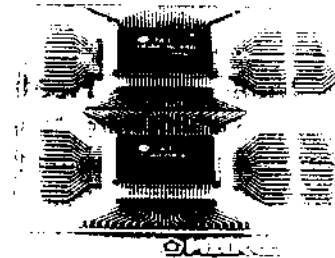

Fig. I

4. Washing

When soldering is completed, wash away the flux.

Note: While there is merits to solder by Hot air, it's also possible to cause the defects such as solder balls, solder bridges. We recommend you to examine the conditions of soldering sufficiently.

Replacing the Heating Element

1. Remove the screws, slide the tube.

Remove the 3 screws (Fig. I-1, 2, 3) which secure the Handle and slide the cord tube.

2. Open the Handle.

Disconnect the ground wire sleeve (Fig. II-1) and remove the pipe. In the pipe, the quartz glass and heat insulation is installed. Do not drop or miss it.

3. Remove the Heating Element.

Disconnect the terminal (Fig. II-2) and remove the Heating Element.

4. Insert a new Heating Element.

Handle it with care. Never rub the Heating Element wire. Insert a new Heating Element and reconnect the terminal. Reconnect the ground wire after replacing the element. Assemble the Handle in the reverse order of disassembly. Insert the Handle's projection into the hole in the pipe.

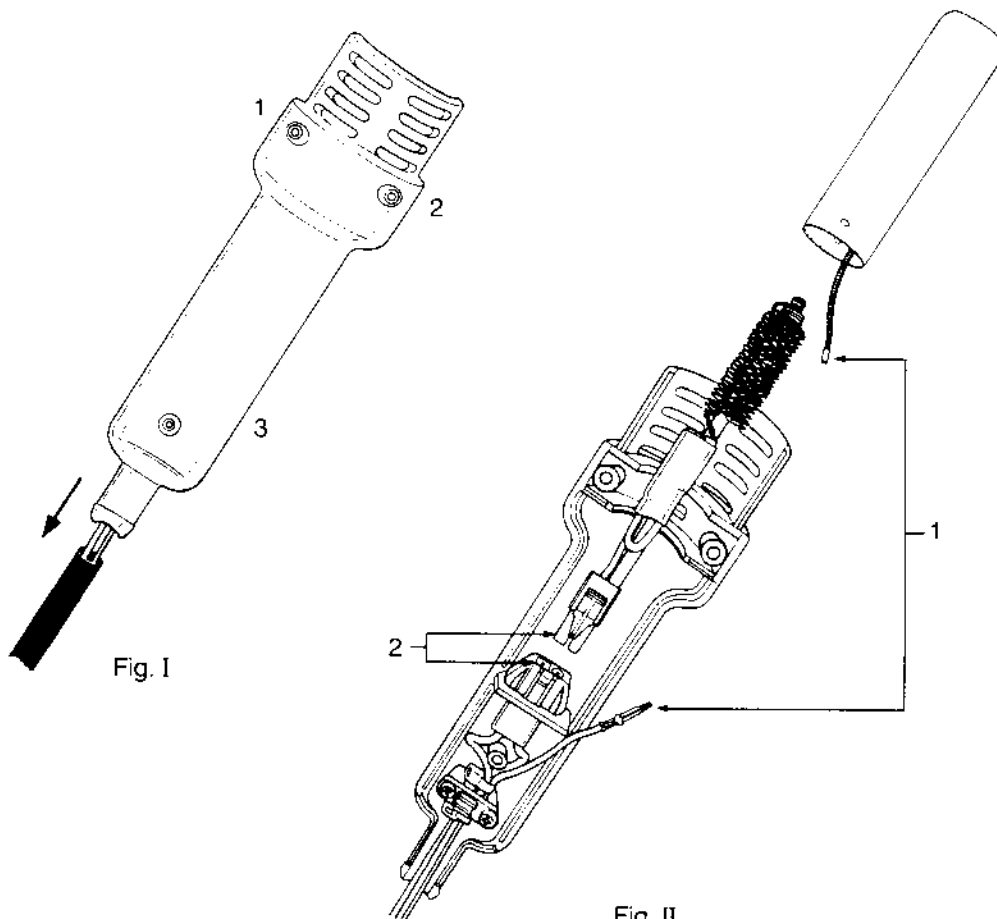

Temperature Distribution Chart

⚠ CAUTION : These charts are for reference. If the thermal protector is tripped, reduce the temperature setting or increase the air flow.

Test criteria: (A1124B ~ A1129B) Measured at the point of 3mm from the nozzle by recorder.
Room temperature 23°C (73.4°F).

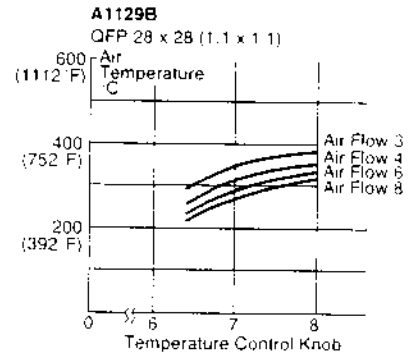
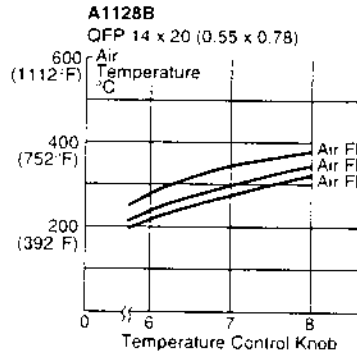
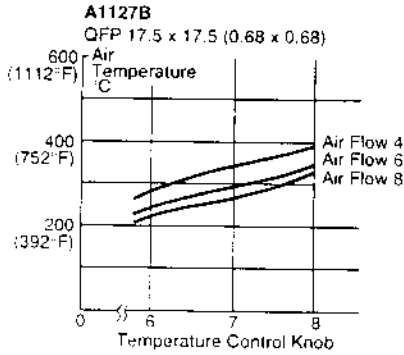
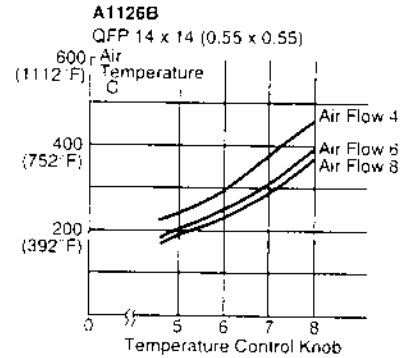
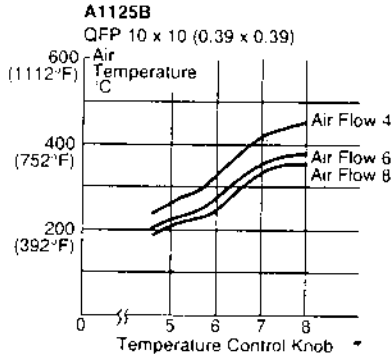
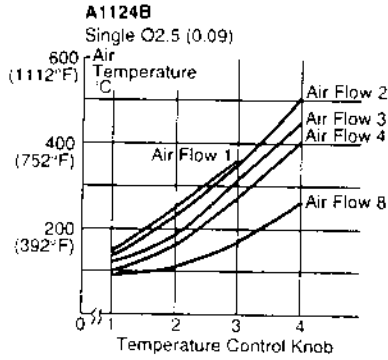

Test criteria: (A1130B ~ A1142B) Measured at the point of 3mm from the nozzle by recorder.
Room temperature 21°C (67°F).

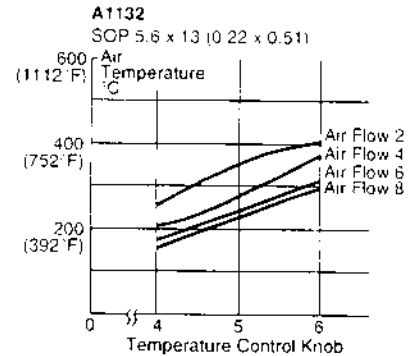
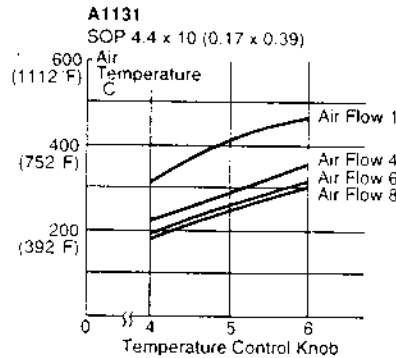
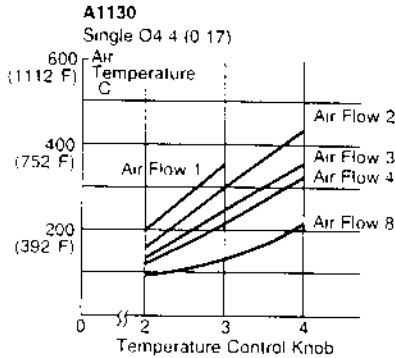

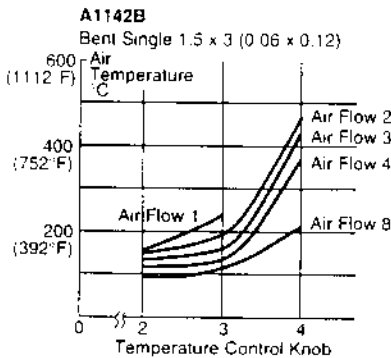
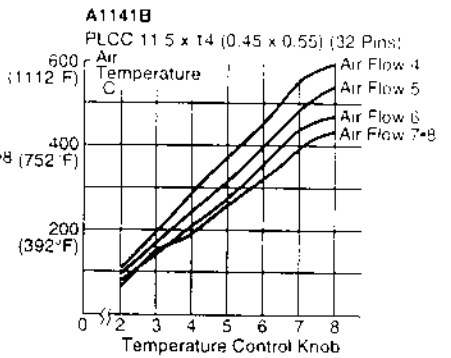
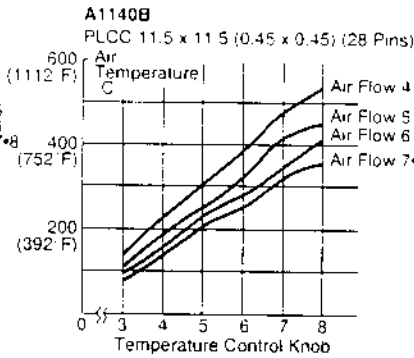
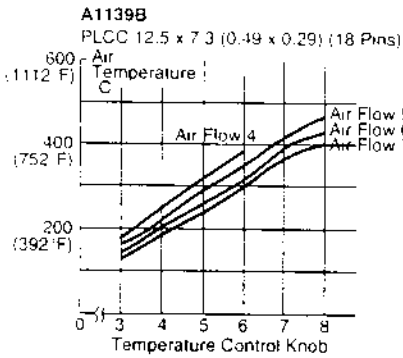
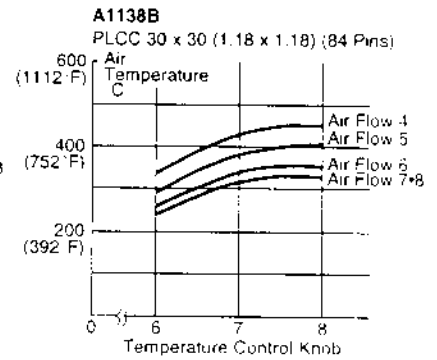
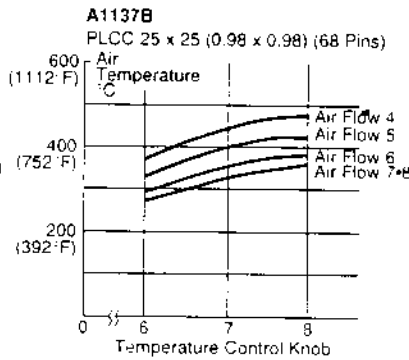
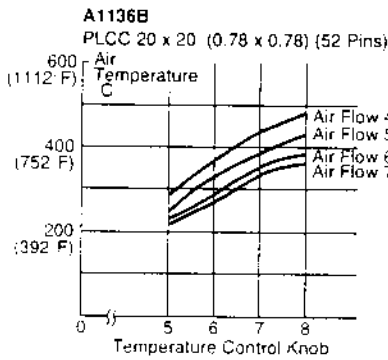
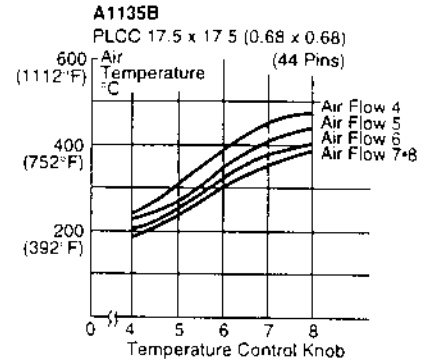
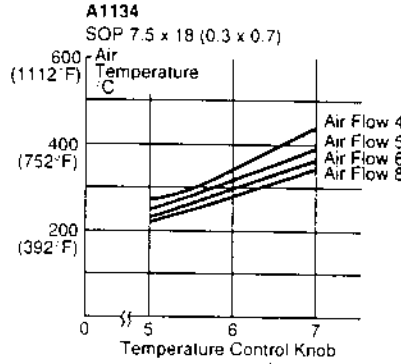
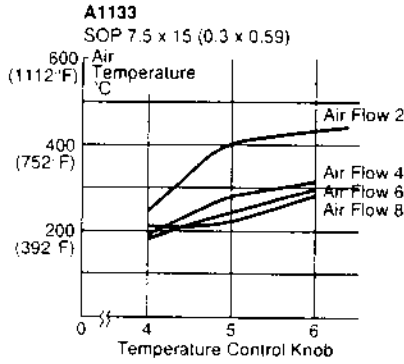

Specifications

Name	HAKKO 850
------	-----------

The specifications written here may be subject to change without notice.

•Station



Power Consumption	20W (When the Power Switch is "OFF" 2W)
Pump	diaphragm pump
Capacity	23ℓ/min (max.)
Outer Dimensions	187(W) × 135(H) × 245(D)mm (7.36 × 5.31 × 9.64 in)
Weight	4kg (approx.) (8.81 lb)

•Iron

Power Consumption	100, 110, 220-240V/250W 120V/260W
Hot Air Temperature	100 ~ 420°C (212 ~ 788°F) (Use A1126)
Length	196mm (7.71 in)
Weight	120g (0.26 lb)

•Option Parts

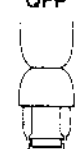
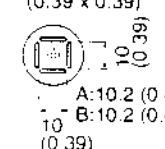
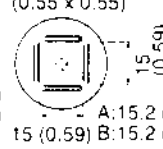
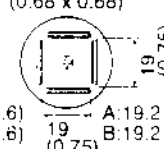
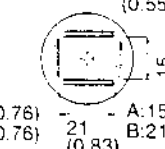
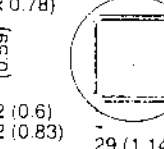
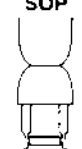
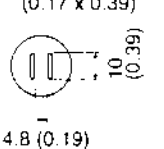
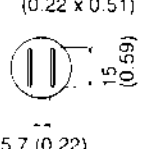
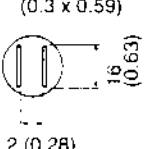
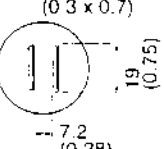
mm (inch) *The size in Name/Specification indicates the size of IC package.

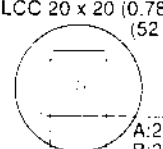
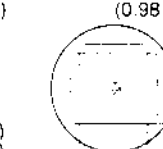
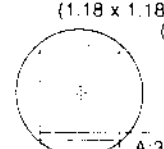
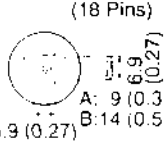
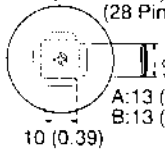
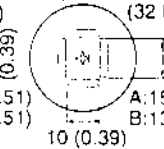
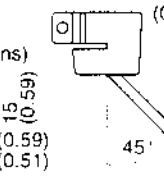
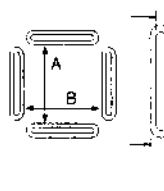
OFF	A1124B Single Q2.5 (0.09)	A1125B QFP 10 x 10 (0.39 x 0.39)	A1126B QFP 14 x 14 (0.55 x 0.55)	A1127B QFP 17.5 x 17.5 (0.68 x 0.68)	A1128B QFP 14 x 20 (0.55 x 0.78)	A1129B QFP 28 x 28 (1.1 x 1.1)
	 Q2.5 (I.D.) (0.09)	 A:10.2 (0.4) B:10.2 (0.4)	 A:15.2 (0.6) B:15.2 (0.6)	 A:19.2 (0.76) B:19.2 (0.76)	 A:15.2 (0.6) B:21.2 (0.83)	 A:29.7 (1.17) B:29.7 (1.17)
SOP	A1130 Single Ø4.4 (0.17)	A1131 SOP 4.4 x 10 (0.17 x 0.39)	A1132 SOP 5.6 x 13 (0.22 x 0.51)	A1133 SOP 7.5 x 15 (0.3 x 0.59)	A1134 SOP 7.5 x 18 (0.3 x 0.7)	
	 Ø4.4 (I.D.) (0.17)	 4.8 (0.19)	 5.7 (0.22)	 7.2 (0.28)	 7.2 (0.28)	
PLCC	A1135B PLCC 17.5 x 17.5 (0.68 x 0.68) (44 Pins)	A1136B PLCC 20 x 20 (0.78 x 0.78) (52 Pins)	A1137B PLCC 25 x 25 (0.98 x 0.98) (68 Pins)	A1138B PLCC 30 x 30 (1.18 x 1.18) (84 Pins)		
	 15 (0.59)	 19 (0.75)	 24 (0.94)	 29 (1.14)		
	A1139B PLCC 12.5 x 7.3 (0.49 x 0.29) (18 Pins)	A1140B PLCC 11.5 x 11.5 (0.45 x 0.45) (28 Pins)	A1141B PLCC 11.5 x 14 (0.45 x 0.55) (32 Pins)	A1142B Bent Single 1.5 x 3 (0.06 x 0.12)		
	 6.9 (0.27)	 10 (0.39)	 10 (0.39)	 1.5 (0.06) (I.D.) 45°	 Air flow 0.8 (0.03) 1.8 (0.07)	

•Replacement Parts

No.	Name
A1143	100V/250W Heating Element
A1144	110V/250W Heating Element
A1145	120V/260W Heating Element
A1146	220V-240V/250W Heating Element
B1438	FP Pick-up (with (S) (L) Wire)
B1439	FP Pick-up Wire (S)
B1440	FP Pick-up Wire (L)

•Note

The following parts has been modified to the new one. When you order the replacement parts, please inform the Part No. to distinguish from the former one.

LED Lamp (Air Flow/Heater Lamp)	No. B1854
Locking Spacer (Securing the P.W.B.)	No. B1114
Air Nozzle	No. B1856

Air Nozzle

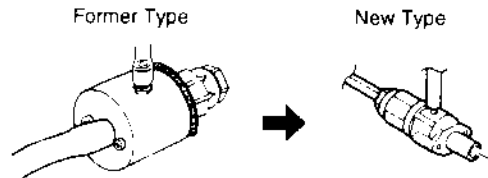

HAKKO CORPORATION

HEAD OFFICE

4-5, SHIOKUSA 2-CHOME, NANIWA-KU, OSAKA, 556-0024 JAPAN
TEL: +81-6-6561-3225 FAX: +81-6-6561-8466

OVERSEAS AFFILIATES

U.S.A.: AMERICAN HAKKO PRODUCTS, INC.
25072 ANZA DR. SANTA CLARITA, CA 91355 U.S.A.
TEL: (661) 294-0090 FAX: (661) 294-0096
Toll Free: (800) 888-HAKKO www.hakkousa.com

S'PORE: HAKKO PRODUCTS PTE., LTD.
1 GENTING LINK #02-04 PERFECT INDUSTRIAL
BUILDING SINGAPORE 349518
TEL: 744-2277 FAX: 744-0033

HONG KONG: HAKKO DEVELOPMENT CO., LTD.
ROOM 1504 EASTERN HARBOUR CENTRE,
28 HOI CHAK STREET, QUARRY BAY, HONG KONG
TEL: 2811-5588 FAX: 2590-0217

PHILIPPINES: HAKKO PHILS TRADING CO., INC.
NO. 415 WINDSOR TOWER CONDOMINIUM,
163 LEGASPI ST., LEGASPI VILLAGE MAKATI
METRO MANILA, PHILIPPINES
TEL: (02) 817-0712, 815-4993 FAX: (02) 810-7649

MALAYSIA: HAKKO PRODUCTS SDN BHD
MALAYSIA HEAD OFFICE: PETALING JAYA
LOT 35/1 THE HIGHWAY CENTRE JALAN 51/205-46050
PETALING JAYA SELANGOR DARUL EHSAN, MALAYSIA
TEL: (03) 794-1333 FAX: (03) 791-1232

PENANG BRANCH: TEL: (04) 644-8689 FAX: (04) 644-8628
JOHORE BAHRU BRANCH: TEL: (07) 236-7766 FAX: (07) 237-4655

Hakko 850 Notes to the user

1. Additions of Optional Parts

mm (inch)

•Nozzles

NOTE

The size in Name/Specification indicates the size of IC package.

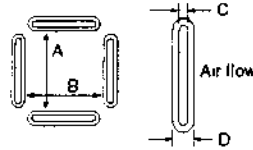

	C 0.8 (0.03) D 1.8 (0.07)	C 1.0 (0.04) D 1.8 (0.07)	C 1.0 (0.04) D 2.0 (0.08)	C 0.8 (0.03) D 2.0 (0.08)
No.	A1180B~A1188B A1203B, A1214B A1215B A1257B~A1265B	A1189B	A1191	A1192

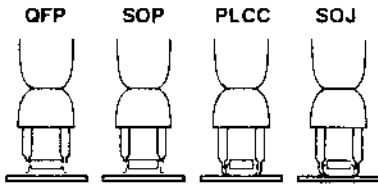

A1180B BQFP 17×17
(0.67×0.67)

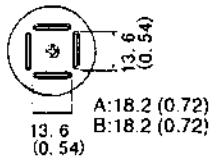

A1181B BQFP 19×19
(0.75×0.75)

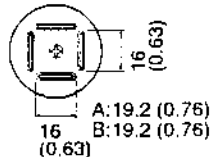

A1182B BQFP 24×24
(0.94×0.94)

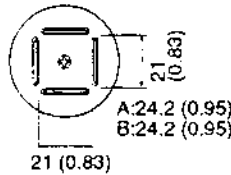

A1183 SOJ 15×8
(0.59×0.31)

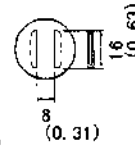

A1184B SOJ 18×8
(0.71×0.31)

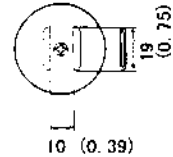

A1185B TSOL 13×10
(0.51×0.39)

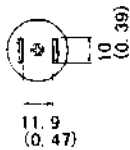

A1186B TSOL 18×10
(0.71×0.39)

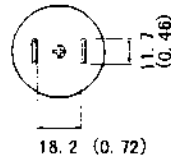

A1187B TSOL 18.5×8
(0.73×0.31)

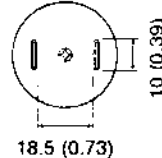

A1188B PLCC 9×9
(0.35×0.35)
(20 Pins)

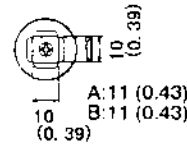

A1189B PLCC 34×34
(1.34×1.34)
(100 Pins)

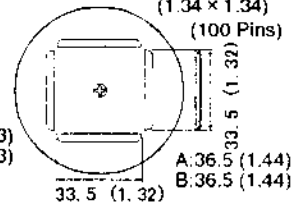

A1190 Dual Single
2.5×9.5
Pitch (0.09×0.37)

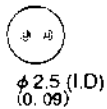

A1191
SIP 25L (0.98)

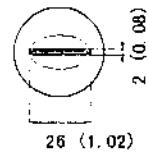

A1192
SIP 50L (1.97)

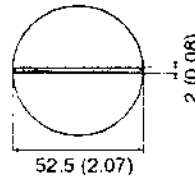

A1203B QFP 35×35
(1.38×1.38)

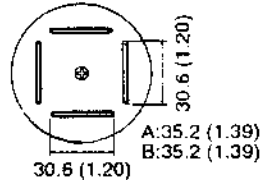

A1214B SOJ 10×26
(0.39×1.02)

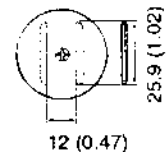

A1215B QFP 42.5×42.5
(1.67×1.67)

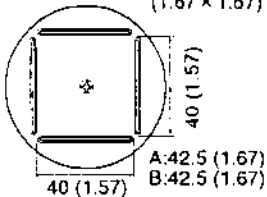

A1257B SOP 11×21
(0.43×0.83)

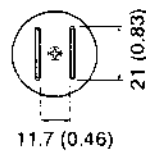

A1258B SOP 7.6×12.7
(0.3×0.5)

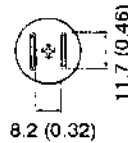

A1259B SOP 13×28
(0.51×1.1)

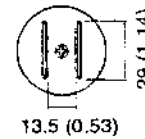

A1260B SOP 8.6×18
(0.34×0.71)

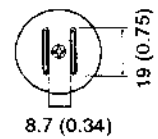

A1261B QFP 20×20
(0.78×0.78)

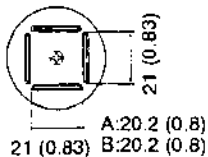

A1262B QFP 12×12
(0.47×0.47)

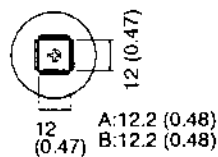

A1263B QFP 28×40
(1.1×1.57)

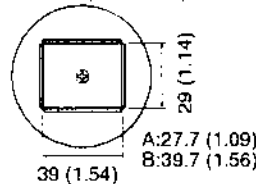

A1264B QFP 40×40
(1.57×1.57)

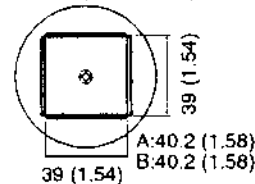

A1265B QFP 32×32
(1.26×1.26)

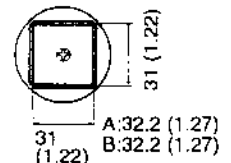

A1325 Dual Single φ 1.5×5-10
(0.06×0.2-0.39)
Adjustable Pitch

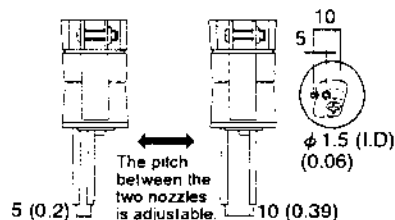

2. Temperature Distribution Chart

Test Criteria: (A1180B~A1257B, A1259B~A1325)

Measured at the point of 3mm from the Nozzle by recorder.

Room Temperature 24°C(75.2°F).

(A1258B) Room Temperature 28°C(82.4°F).

